

**AMATEUR RADIO EXAMINATION
- QUESTION PAPER -**

INDEX NO.	AMR-10-2010-							
IC NO.			-					

IC COLOUR

DAY : SUNDAY
DATE : 17th OCTOBER 2010M / 9 ZULKAEDAH 1431H
TIME : 0930 - 1130 (2 HOURS)
VENUE : B13, AITI BUILDING, KG. ANGGEREK DESA

**TO ALL CANDIDATES
PLEASE READ CAREFULLY THE INSTRUCTIONS BELOW
BEFORE YOU START YOUR EXAMINATION PAPER**

1. This examination paper contains **60 multiple choice questions** and is separated into 2 sections. Section A contains **30 multiple choice questions**, and Section B also contains **30 multiple choice questions**, please answer all.
2. To answer, please **circle** the letters A, B, C or D that have been provided in the Answer Sheet.
3. Participants need to pass in both sections (Section A and B). Failure in either section will be counted as an automatic Fail.
4. Allowed writing material is **BLUE** or **BLACK** pens only. Pencils and other writing materials are prohibited.
5. **Strike** answers that are to be changed. The use of erasers, blanco or the likes is prohibited.
6. Mathematical work is allowed only on the question paper. Doing mathematical work on other paper is **prohibited**.
7. Examination Paper and Answer Sheet are to be returned to the invigilator, even if no questions are answered.
8. Participants are **prohibited** to speak, borrow writing materials or calculators or the likes during the whole duration of the exam.
9. Identification Card or passport is to be placed on the table for the whole duration of the examination. Participants are not allowed to leave their seats without permission from invigilators.
10. If it is found that participants are not following instructions, orders or warnings during the examination, their names will be recorded for further action or immediate disqualification.

SECTION A

This section contains 30 questions. Answer all.

1. According to the Telecommunication Order 2001, any person who establishes, installs, maintains, provides or operates a radio-communication service or any radio-communication equipment in any place or on board any vessel, aircraft or in any vehicle in Brunei Darussalam without a licence granted shall be guilty of an offence. Which of the statement below is CORRECT?
 - A. Any person guilty of an offence shall be liable on conviction to a fine not exceeding \$10,000, imprisonment for a term not exceeding 1 year or both.
 - B. Any person guilty of an offences shall be liable on conviction to a fine not exceeding \$10,000, imprisonment for a term not exceeding 3 years of both.
 - C. Any person guilty of an offence shall be liable on conviction to a fine not exceeding \$50,000, imprisonment for a term not exceeding 3 years or both.
 - D. No fine is liable at all.

2. In what Region and Zone is Brunei Darussalam located?
 - A. Region 28, Zone 3
 - B. Region 3, Zone 28
 - C. Region 38, Zone 2
 - D. Region 2, Zone 38

3. If you purchase amateur radio equipment from outside the country, what is the right thing to do upon arrival at the custom's control post?
 - A. Bring in the said equipment without notifying Royal Brunei Custom and Excise Officials and seek approval from AITI
 - B. Pay import tax for the equipment without seeking approval from AITI
 - C. Declare the equipment to the Royal Brunei Custom and Excise officials, seek approval from AITI and pay import tax for the equipment
 - D. Bring the equipment directly to AITI officials for approvals without having to pay for import tax.

4. What are the complete details inside the logbook for amateur radio operators everytime they are on air?
 - A. Duration of conversation time, station callsign which with you are communicating with, frequency band and emission.
 - B. Duration of conversation time, station which with you are communicating with, frequency band, emission and power output, signal report, QSL.
 - C. Date, frequency band and emission, power output, conversation time, signal report, statement.
 - D. Date, frequency band and emission, power output, station callsign which you are communicating with, start and end of conversation time, signal report, QSL.

5. Amateur Radio service is defined as
 - A. a radio station that is owned by a commercial entity. To be qualified as such, it must also be advertiser-supported and for-profit.
 - B. a radio-communications service in which a station is used for the purpose of self-training, intercommunication and technical investigations carried out by amateurs.
 - C. a conventional radio system uses a dedicated channel (frequency) for each individual group of users for public and commercial purposes.
 - D. a cellular service that can be used for voice and data.

6. What is the primary requirement for a VHF (Standard) licence holder to upgraded to a HF (Advance) licence?
 - A. To sit and pass an HF licence written examination.
 - B. Holding a standard licence for a minimum of six (6) months and to submit a logbook indicating active communication for the past six (6) months.
 - C. Holding a standard licence for a minimum of three (3) months and to submit a logbook indicating active communication for the past six (6) months.
 - D. To sit and pass an HF licence practical examination.

7. Is an approved amateur radio equipment allowed to be modified?
 - A. With permission from the Royal Brunei Police Force and Royal Brunei Custom and Excise.
 - B. If the equipment is modified by a certified dealer.
 - C. Any approved equipment is not allowed to be modified, unless with written approval from AITI.
 - D. Once you have obtained a licence and type approval for your equipment, you can immediately modify.

8. If an amateur radio licensee changes to their address and/or vehicle registration, the licensee should notify
 - A. Registrar of Society
 - B. Amateur Radio Clubs/Association
 - C. Relevant Government Ministry
 - D. Authority for Info-communications Technology Industry of Brunei Darussalam

9. Which of the following message below should not be send?
 - A. A message to an overseas amateur of any country.
 - B. A message relating to WX.
 - C. A message relating to market a business.
 - D. A message to a large group of amateurs.

10. Which of the statement below is CORRECT regarding installation of amateur radio equipment in a premise?
 - A. One unit of licensed radio equipment is only allowed for one premise unless stated otherwise in the license.
 - B. Radio equipment can be installed in any premise without any valid amateur radio license.
 - C. Installation of radio equipment and antenna is not required to meet the specifications and regulations of building/residential code.
 - D. One unit of licensed radio equipment can be transferred anytime from one premise to another.





11. Zain and his son Zaini is having an amateur radio conversation. Which set of conversations below should they avoid:
- A. Religion, Business, Politics, Racial and Ethnic Slurs.
 - B. Hobbies, Education, and Entertainment.
 - C. Sport, Personal details and Socializing.
 - D. Weather, Location and Q-Codes.
12. For signal strength scale, what is the scale for 'fairly good signal' and 'extremely strong signal'?
- A. 5 and 9
 - B. 1 and 9
 - C. 9 and 5
 - D. 1 and 5
13. A station 'Callsign' is sent for the purpose of identification at the start of transmission and end of transmission. It should...
- A. Be mentioned once after the first 60 minutes
 - B. Be mentioned once after the first 15 minutes
 - C. Be repeated every 15 minutes
 - D. Be repeated every 60 minutes
14. What is required by AITI during random amateur radio inspections?
- A. Station Log Book and a valid amateur radio licence
 - B. Station log book and a certificate from Radio Organisation
 - C. Station log book and a valid driving licence
 - D. A certificate from any Radio Organisation and a valid driving licence
15. An operator has the callsign, V8V2010. He/she is operating
- A. Marine Radio
 - B. Amateur Radio
 - C. Aeronautical Radio
 - D. Satellite Radio
16. A visiting full licensed amateur radio user comes to Brunei Darussalam. His/Her callsign will be
- A. prefixed by V85/ and suffixed by His/Her callsign
 - B. suffixed by V85/ and prefixed by His/Her callsign
 - C. prefixed by V89/ and suffixed by His/Her callsign
 - D. prefixed by V85/ and suffixed issued by AITI
17. For duplex, what is the frequency band used by an amateur radio for a "Very High Frequency" in Brunei Darussalam?
- A. 144.0000 MHz – 148.0000 MHz
 - B. 144.0125 MHz – 148.0000 MHz
 - C. 146.0125 MHz – 148.0000 MHz
 - D. 146.0000 MHz – 148.0000 MHz

18. For 160 meter band, which one of the following frequency band is correct?
- A. 16.000 – 16.999 MHz
 - B. 5.650-5.925 MHz
 - C. 1.800 – 2.000 MHz
 - D. 144.000 – 148.000 MHz
19. What is the 'Q' code for "Will you tell my frequency?" and "Are you busy?"
- A. QSL and QRB
 - B. QSU and QSO
 - C. QRM and QRB
 - D. QRG and QRL
20. What does 'CQ' and 'WX' stands for?
- A. Calling all station and Distance foreign countries
 - B. Call quit/Closing down and Weather
 - C. Calling all station and Weather
 - D. Station call interference and Distance foreign countries
21. All amateur radio equipment in a station has to be maintained and used
- A. With support from IEE
 - B. Approximately 20% of the approved maximum power
 - C. Not to interfere with other radio-communication services
 - D. With complete discretion by AITI officials
22. Amateur radio services, as a secondary service, are permitted to use the frequency band if
- A. amateur radio user feels experienced enough
 - B. it only interferes with other primary services
 - C. it does not cause any interference to primary service
 - D. the primary service operates at a lower power and used at the same time
23. Amateur radio repeater frequencies in Brunei are coordinated by:
- A. Royal Brunei Police Force (Signalling Division)
 - B. Amateur Radio Society
 - C. Repeater committee
 - D. Authority for Info-communications Technology Industry of Brunei Darussalam (AITI)
24. The maximum output power permitted for an amateur radio station is
- A. 150 Watts
 - B. 100 Watts
 - C. 50 Watts
 - D. 25 Watts
25. The amateur radio license classes in Brunei are:
- A. Novice, Advances
 - B. Standard, Advanced
 - C. Novice, Technician
 - D. Class 1, Class 3

26. What kind of amateur station simultaneously retransmits the signal of other stations on another frequency?
- A. Repeater Station
 - B. Beacon Station
 - C. Telex Station
 - D. Relay Station
27. An amateur radio licensee should renew their licence every?
- A. No renewal required
 - B. 3 months
 - C. 12 months
 - D. 24 months
28. Where does a Brunei Darussalam Amateur Radio licence allow you to operate?
- A. From anywhere in the world
 - B. From wherever the Amateur Radio Service is regulated as stated in the licence issued
 - C. From a country that shares a third party agreement with Brunei Darussalam
 - D. Only from the mailing address printed on your license
29. What are the requirements for applying an Amateur Radio licence upgrade (ie. V89 – V85)?
- A. The licence holder must fill up the Amateur Radio Callsign Application form and submit a minimum six (6) month logbook.
 - B. Licence holder must hold a valid Amateur Radio licence for at least three (3) years
 - C. To purchase an amateur HF radio equipment before applying.
 - D. No further process required upon passing your amateur radio examination.
30. A 'line of sight' transmission between two stations uses mainly the
- A. ionosphere
 - B. troposphere
 - C. sky wave
 - D. ground wave

SECTION B

This section contains 30 questions. Answer *all*.

31. Radio wave polarization is defined by the orientation of the radiated:
- A. magnetic field
 - B. electric field
 - C. inductive field
 - D. capacitive field
32. The relationships between, 'Voltage (V)', 'Resistor (R)' and 'Current (I)' is
- A. $I = V/R$
 - B. $V = R/I$
 - C. $I = VR^2$
 - D. $V = I^2R$
33. The unit for resistance is
- A. Farad
 - B. Ohm
 - C. Watt
 - D. Ampere
34. Which instrument would you use to measure an electric current?
- A. Ammeter
 - B. Thermometer
 - C. Voltmeter
 - D. Ohmmeter
35. What is the symbol for capacitor
- A. 
 - B. 
 - C. 
 - D. 
36. A 50 hertz current in a wire means that:
- A. A potential difference of 50 volts exists across the wire
 - B. The current flowing in the wire is 50 amperes
 - C. The power dissipated in the wire is 50 watts
 - D. A cycle is completed 50 times in each second
37. The voltage through a $125\text{k}\Omega$ resistor is 100 V. What is the current across this resistor?
- A. 125 milliamps
 - B. 8 amps
 - C. 0.8 milliamps
 - D. 1.25 amps

38. The energy supplied to a secondary cell is stored as
- A. a charge of electricity
 - B. electrical energy
 - C. chemical energy
 - D. joules with a potential difference.
39. The wavelength of a signal in free space with a frequency of 100MHz is
- A. 3 meter
 - B. 30 meter
 - C. 3 millimeter
 - D. 3 cm
40. If ' λ ' is wavelength, ' c ' is speed of light and ' f ' is frequency, which formula listed below is correct?
- A. $\lambda = fc$
 - B. $f = \lambda/c$
 - C. $c = f^2\lambda$
 - D. $c = f\lambda$
41. Which of the following of the components is used to make RF filters?
- A. Diode and Resistor
 - B. Zener Diode and Zeti Diode
 - C. Capacitor and LEDs
 - D. Inductors and Capacitors
42. What are three good electrical conductors
- A. Copper, gold, mica
 - B. Gold, silver, wood
 - C. gold, silver, aluminium
 - D. copper, aluminium, paper
43. What is the Phonetic Code for 'V89YKB' ?
- A. Victor, Eight, Nine, Yankee, Kilo, Bravo
 - B. Victoria, Eight, Nine, Yankee, Kilo, Bravo
 - C. Victoria, Eight, Nine, Yahoo, Kilo, Bravo
 - D. Victor, Eight, Nine, Yahoo, Kathy, Bravo
44. The main advantage of the yagi aerial as compared with dipole is
- A. Smaller physical dimensions
 - B. Increased forward gain
 - C. A wider beam width
 - D. A better match for the feeder

45.

Symbol transistor

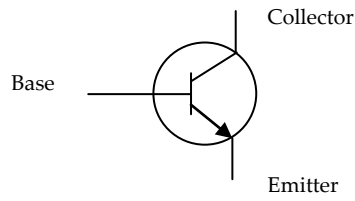

With reference to the transistor symbol above, which one is the correct answer?

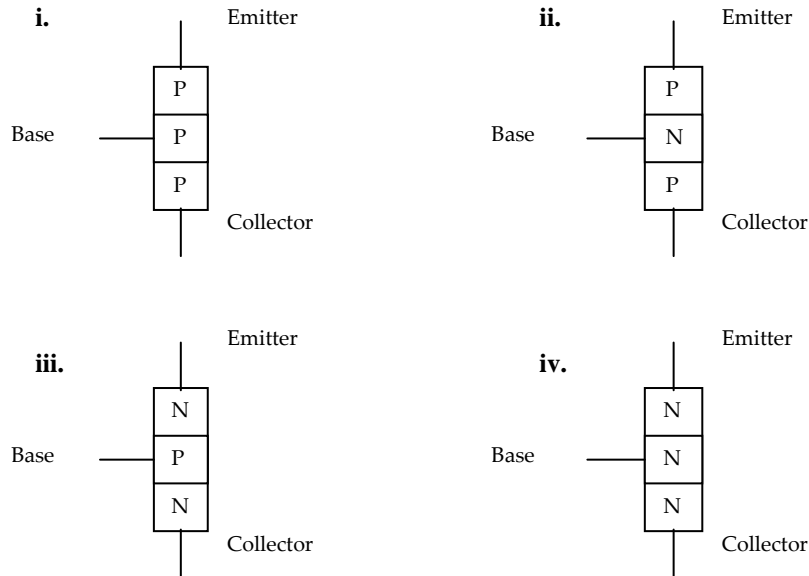

- A. i
- B. ii
- C. iii
- D. iv

46. In the diagram below, indicate the current flow in the semi-conductor diode.

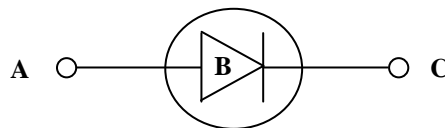

- A. From A to B
- B. From A to C
- C. From A to B and B to A
- D. From C to A

47. What is the frequency of the signal shown below at speed 3×10^8 m/s, if both half-cycle are of equal length?

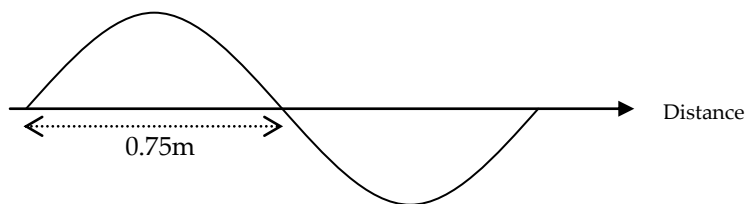

- A. 100 MHz
- B. 200 MHz
- C. 450 MHz
- D. 900 MHz

48. What is the function of an antenna tuner?
- A. To improve power efficiency between transceiver and antenna by matching the impedance
 - B. To tune the frequency
 - C. To maintain power transmission at a safe level
 - D. To provide excellent grounding to the equipment during lightning
49. A low pass filter will
- A. suppress sub-harmonics
 - B. reduce harmonics
 - C. always eliminate interference
 - D. improve harmonic radiation
50. For long distance propagation, the radiation angle of RF energy from antenna should be
- A. Less than 30 degrees
 - B. More than 30 degrees but less than 45 degrees
 - C. More than 45 degrees but less than 90 degrees
 - D. 90 degrees
51. What is the modulation used in "Very High Frequency" and "High Frequency" respectively?
- A. Single band and multiple band
 - B. Frequency modulation and amplitude modulation
 - C. Amplitude modulation and frequency modulation
 - D. Quadrature amplitude modulation and phase modulation
52. Process of modulation allows
- A. Voice and Morse code to be combined
 - B. Information to be conveyed over a carrier wave
 - C. Information to be removed from a carrier wave
 - D. None of the above
53. A power amplifier has a gain of 5. If you input 2W, the output would be?
- A. 0.2W
 - B. 10W
 - C. 0.4W
 - D. 5W
54. Harmonic frequencies are
- A. Always lower in the frequency than the fundamental frequency
 - B. At multiples of the fundamental frequency
 - C. Any unwanted frequency above the fundamental frequency
 - D. Any frequency causing TVI
55. What is used to convert sounds from our voice into radio signals?
- A. Transmitter
 - B. Receiver
 - C. Speaker
 - D. Antenna

56. Radio Horizon is define as
- A. The line of sight between two transmissions
 - B. The communications done in coastal areas
 - C. The point where radio signals between two points are blocked by the curvature of the Earth
 - D. The communications to the space-station during ideal weather condition
57. The frequency band '3 MHz – 30 MHz ' is categorised under?
- A. Very high frequency
 - B. High frequency
 - C. Ultra high frequency
 - D. Low frequency
58. Define which antenna comprises of a center-fed driven element for transmitting or receiving radio frequency energy?
- A. Omni-directional Antenna
 - B. Half wavelength dipole
 - C. Yagi Antenna
 - D. Straight wire antenna
59. The purpose of a 2 meter repeater is to
- A. Provide amateur operation without the use of callsigns
 - B. Provide communication for emergency purposes
 - C. Make possible VHF contacts over longer distance
 - D. Experiment with frequency shift techniques
60. A standing wave meter (SWR) is used to check the
- A. Height of the tower
 - B. Efficiency of a transmitter
 - C. Resonant frequency of an aerial
 - D. Matching of the transmitter to the aerial system